



Multifunctional handheld nuclear radiation meter
(Gamma-Spectrometer and Radiation Dosimeter) KC761x

User Manual

Support version FW V1.2 HW V1.2

科新社

Executive Summary

This manual introduces the concept and basic principle of energy spectrometer, and provides a comprehensive explanation of the structure, functions and usage of the KC761x energy spectrometer.

Development Team

Chief Engineer

Tao Le

Engineers

Li Yun, Yuan Xinzhi, Chen Wei

Consultant Experts

Shi Congwei, Xu Nuo, Yang Tianhao, Ke Wei

KC761x Multifunctional Handheld Energy Spectrum Analyzer User Manual

Author(s): Liu Hu

(Instrument Research Institute, Kechuang Institute)

KEXINSHE

Correspondence to the Agency: 028-86691700

Second edition, August 2023 Opening: 841×1189 1/64

First printing August 2023 sheet count: 0.5

Print run: 0-500 Word count: 25,000 words

Security matters

In this brochure:



"Dangerous" means a matter that may result in personal injury;



"Warning" means a matter that may lead to the loss of equipment or a major error;



"Important" refers to a statement that requires special attention.



Dangerous

Remove the sensor module.

Throw into the fire or place in a hot place.

Power is supplied by means or parameters other than those indicated by the instrument and specified in the manual.

Storage or use in environments with combustible/explosive gases, dusts.

Use when the instrument is malfunctioning or parts are missing.

Place it in a place where children can reach it.



Warning

This instrument is not a consumer product and should only be used by professionals in accordance with the manual and the manufacturer's regulations.

Instruments are not to be disassembled by non-authorized personnel.

Modifications are prohibited.

Radio transmitting devices (2.4GHz 802.11b/g/n, Bluetooth) are included, please observe local laws and regulations.

Pay attention to the energy range, KC761(NO model letter version) paying particular attention to dose measurements that are not suitable for low-energy rays (e.g., low-energy X rays), where the results may be grossly underestimated. In this case please use KC761B model.

Disclaimers

This instrument is a professional device, not a consumer product, and the rules for consumer products do not apply.

To the extent permitted by law, the maximum liability of the manufacturer shall be the purchase price, regardless of damages, and shall not be liable for any loss of time, business, inconvenience, profit, abuse, or any consequential damages. The manufacturer's decision to repair, replace or return the product and refund the purchase price is the sole remedy for the user and the purchaser. The warranty period is the final period for which the manufacturer is liable for the product.

Users are requested to comply with nuclear safety related regulations and use it only for legitimate scientific research, teaching, environmental protection, security and other purposes, and prohibit it from being used for purposes directly related to life safety or any illegal purposes. Designers, producers, sellers, service providers, community event organizers, etc. of KC761x have fulfilled the necessary publicity and warning obligations and are not responsible for the user's actions.

The instrument has a networking feature, which is a convenience only and not an official feature. Users should fully assess the risks of networking before enabling the networking function. When networking, the user should ensure that the tested object does not involve state secrets, trade secrets, personal privacy or other non-disclosable contents, and know that the data may be erroneous, tampered with, contaminated, stolen, etc. The system may also be subject to network attacks. The manufacturer does not make any guarantees for information security.

No guarantee of feasibility for aviation, aerospace, submarine, life support and other scenarios. Any promises made by the seller do not imply knowledge of or agreement with the manufacturer.

* * *

Packing list

Spectrometer..... 1pc
Carrying rope.....1pc
User manual 1copy

Power supply method

One of the following power supply methods can be used

a. (1) 5AA NiMH/NiCd battery \times 3, nominal voltage 1.2V.

(2) 5AA/LR6 dry batteries \times 3, including carbon, alkaline batteries and disposable lithium-iron batteries with a nominal voltage of 1.5V;

It should be used correctly and maintained properly according to the requirements of the battery manufacturer.

b. 5V \pm 10%, ripple <1% via USB (Type-C) interface.

i Due to the low power consumption, some cell phone chargers will assume there is no load and automatically sleep. with PD fast charging protocol cannot be powered (no CC pin pull-down resistor).

c. POE power supply through network port, 24~48V.

The above three methods can be used simultaneously. KC761B can charge the NiMH/NiCd battery.

Exposure limits

Exposure to the following types and intensities of radiation only:

a. γ rays (including X rays), <6MeV, \leq 10Gy/h

b. β rays, <6MeV, \leq 1Gy/h

c. α rays, <12MeV, \leq 1Gy/h

d. Neutrons, $\leq 1 \times 10^5 \text{cm}^{-2}\text{s}^{-1}$

e. Other, <12MeV, \leq 1mGy/h,

i Not suitable for applications requiring extremely high reliability. This instrument may go down or malfunction under certain types and intensities of radiation exposure.

Warranty

The instrument is guaranteed for 1 year or an accumulated dose of 10Gy, whichever comes first. The warranty period of the optional sensor is determined separately. During the quality guarantee period, the manufacturer is responsible for free repair if the product fails due to quality problems.

The following are not covered by the warranty:

Aging, wear and tear, appearance damage; collision, drop, extrusion, pinprick and other violent damage; sensor damage after tearing off or damaging the protective film of the sensor; using non-specified power supply; lightning, electric shock, EMP attack, etc.; exceeding the allowable temperature and humidity, altitude, etc.; Instrument internal liquid feed, corrosive gas, radioactive dust, etc.; disassembly, self-repair, modification; failure caused by not operating in accordance with the user manual; abnormalities following exposure to neutrons or other irradiation capable of producing induced radioactivity; the presence of radioactive contamination; failure caused by irradiation exceeding the exposure limit; battery leakage, explosion; other failures not caused by quality problems.

If the irradiation causes software failure, the manufacturer will re-program it free of charge during the warranty period.

The user can send the instrument back to the manufacturer's after-sales service department through the dealer or by himself, accompanied by a description of the fault phenomenon and contact information. After receiving the instrument, the manufacturer will evaluate the fault and repair it if it is covered by the warranty, while the repair cost will be evaluated and explained to the user if it is not covered by the warranty.

 The repaired equipment **must not** be radioactive or contaminated with other dangerous substances, and the activity of induction radioactivity must not exceed 2.5nCi, otherwise the user will be held responsible.

Environmental Protection

This instrument contains plastic housing, circuit board and its attached electronic components, metal parts (brass, iron and nickel, tin plating), glass, silicone rubber seals and scintillation crystals and other parts. After the instrument is disposed of, it should be recycled separately.

Due to the necessity of detecting radiation and the need to consider the reliability for extreme environments, this instrument contains toxic and hazardous substances.

In the following table, × indicates that the content exceeds the limit value of GB/T 26572-2011 or is dangerous.

Component name	The composition and content of toxic and harmful substances in products						
	Lead	Mercury	Hexavalent chromium	Cadmium	Thallium	Polybrominated biphenyls	Polybrominated diphenyl ethers
Circuit Boards	×	○	○	○	○	○	○
Scintillator	○	○	○	○	×	○	○
Other	○	○	○	○	○	○	○

The environmentally safe service life of this instrument is tentatively set at 10 years.

Table of Contents

1、 Overview.....	1
1.1、 Principle of energy spectrometer	2
1.1.1、 Scintillation detector	3
1.1.2、 Semiconductor detectors	4
1.1.3、 Multi-channel analyzer.....	5
1.2、 Energy resolution.....	7
1.3、 Dose rate	8
2、 Features and functions of the instrument.....	9
2.1、 Characteristics of the instrument	10
2.2、 Sensor.....	11
2.3、 The performance of the instrument.....	12
3、 Installation of the instrument	15
3.1、 Installing the battery	15
3.2、 Fixed installation	17
3.3、 Install TF card	17
3.4、 Enabling the network.....	17
3.5、 Pulse output interface.....	18
4、 Operation guide.....	19
4.1、 Interactive interface	19
4.2、 Function description	22
4.2.1、 Operation status	22
4.2.2、 Basic model	24
4.2.3、 Sensor selection	25
4.2.4、 Alarm.....	25
4.2.5、 Nuclide Identification	34
4.3、 Menu settings.....	30
4.3.1、 MODE menu.....	30
4.3.2、 FUNC menu.....	37
4.4、 Other matters requiring clarification.....	40
4.5、 Usage Tips.....	40
4.5.1、 The best incidence direction and distance.....	40
4.5.2、 Finding unknown sources.....	43
4.5.3、 Protection of the quality of the energy spectrum map	44
5、 Maintenance.....	46
5.1、 Stability of the energy scale	46
5.2、 Using batteries.....	48
5.3、 Use of external power supply.....	49
5.4、 Other Notes	50

1、 Overview

An energy spectrometer is a powerful radiation testing instrument, usually used to test the energy and magnitude of rays.

The common Geiger counter is an old and simple instrument, which usually can only determine the magnitude of the radiation and provides very limited information. In order to clarify the nature of the radiation, the easy way is to determine both the energy and the magnitude of the radiation, which requires an energy spectrometer.

For light, the graph drawn with its wavelength as the horizontal axis and its size as the vertical axis is called a spectrogram. The energy and wavelength of rays can be converted into each other, the shorter the wavelength (the higher the frequency), the greater the energy. In the case of X rays rays or γ -rays, using wavelength as the horizontal axis is not intuitive enough, so instead, using energy as the horizontal axis and size as the vertical axis, the plotted spectrum is the energy spectrum.

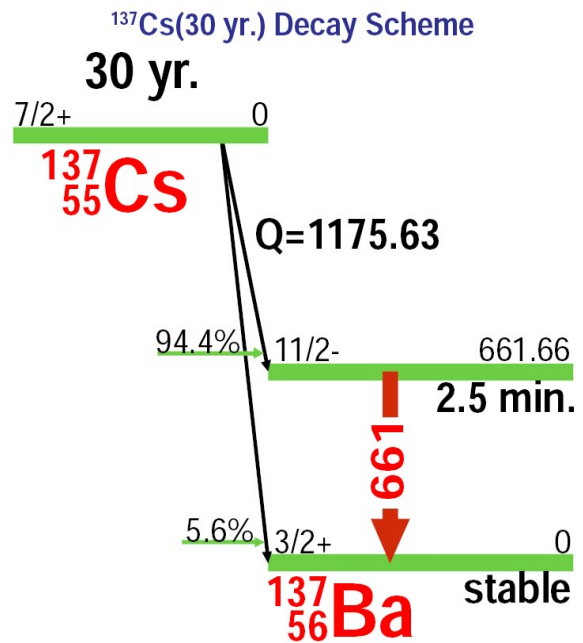
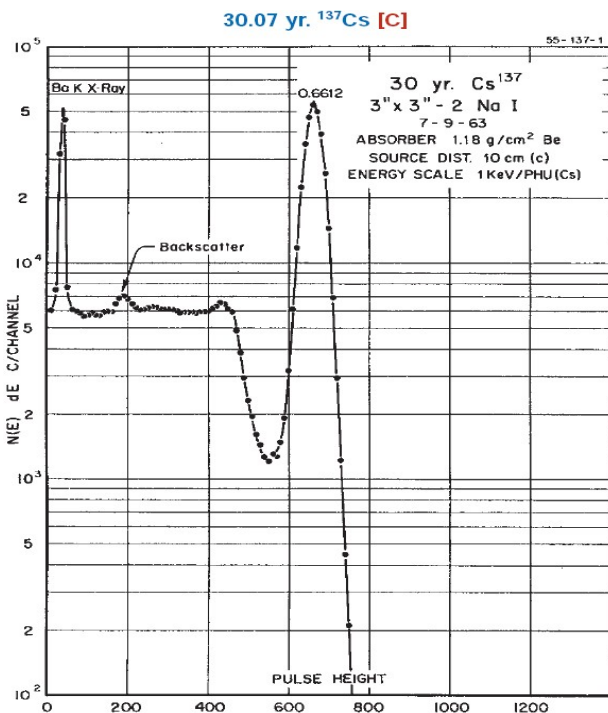

Left: γ -ray energy spectrum of ^{137}Cs , Right: Decay process of ^{137}Cs (R.L.Heath)

In addition to γ -rays, other radiations, such as α and β -rays, also exist in terms of energy levels, and their energy spectra can be obtained using appropriate techniques. The energy of solid particle rays can be attenuated

as they pass through the medium, so different test environments will result in different energy spectra, and measurements in vacuum are usually recommended. And it can be roughly assumed that the γ -rays are only attenuated in size, and the energy always remains the same.

In the case of visible light, for example, size (magnitude) refers to how bright the light is; energy refers to the color of the light, where color and brightness are separate concepts from each other. Purple light must have a higher energy than red light, but red light can be brighter than purple light.

Energy spectrum is an important technical tool for identifying nuclides and specifying the nature of radiation. Different radioactive elements, it and its decay products emit rays with a specific energy distribution. The energy spectrum of a ray can be determined to know what is emitting it.

Geiger counters are difficult to warn of nuclear accidents or fallout at an early stage. Because normal background radiation can fluctuate widely even at the same location, if the Geiger counter reading changes slightly, it is not possible to distinguish between normal fluctuations and the presence of a nuclear leak. In other words, by the time a nuclear leak can be detected with a Geiger counter, the situation is already more serious. Energy spectrometers, however, can provide more accurate information - even if the magnitude of the radiation does not change significantly - and can provide immediate warning of a nuclear accident or explosion as soon as artificial radionuclides, which are only found inside a nuclear reactor, are detected. At the time of the Chernobyl nuclear accident, European countries were initially alerted by the discovery of the presence of 131 iodine in the air.

1.1、 Principle of energy spectrometer

There are two common principles of energy spectrometry:

(1) Using a scintillator to convert radiation into a flash of light, indirectly measured by measuring the brightness of the flash and the amount of the flash, is called a scintillation detector.

(2) The use of a semiconductor to convert radiation into a moveable charge, and the relatively direct measurement by measuring the amount of charge transferred, is called a semiconductor detector.

This instrument uses the first method for γ -rays and neutrons (optional) and the second method for α and β -rays.

1.1.1、 Scintillation detector

The composition of the scintillator is thallium-activated cesium iodide crystals (standard), or europium-activated strontium iodide crystals (optional). After receiving irradiation from the rays, the scintillator emits fluorescence, usually in the visible range. Due to the photo-quantum characteristics of the high-energy rays, a flash of light is produced for each portion of the rays shining on the crystal. The color of the flash is determined by the crystal composition, the brightness of the flash is determined by the energy of the incident rays, and the number of flashes (frequency) is determined by the magnitude of the incident rays. Since the color of the flash is basically constant, the instrument only needs to be concerned with the brightness and frequency of the flash. Therefore, the task now becomes to convert the flash into an electrical signal for easy measurement with some kind of equipment.

But the flash is very faint, the human eye must be completely adapted to the darkness before it can be seen. The duration of the flash is also very short, a single flash is only a few dozen to hundreds of nanoseconds in width. In order to detect it, it is necessary to use a high-sensitivity photoelectric sensor. This instrument uses a silicon photomultiplier tube (SiPM) to solve this problem. It is sensitive enough to detect even a single photon, but the random fluctuations in the output charge are large. To reduce the fluctuations, multiple SiPMs can be used in combination to form an array.

The SiPM is output as a charge, and its output waveform is a pulse with a steep rising edge and only nanosecond-level width at the top. To save power, this instrument uses analog circuitry for pulse processing. The

electronic circuitry performs charge-to-voltage conversion (Q-V conversion), pulse shaping (pole-zero phase elimination, S-K filtering), and peak hold, and then sends it to the ADC for sampling. After the ADC completes one sampling, the CPU immediately resets the analog circuitry and waits for the next pulse to arrive. In the extreme case, 30,000 pulses can be collected per second, which corresponds to a dose rate of approximately 0.3 mGy/h. Above this dose rate, the instrument is unable to perform energy spectrum analysis, and can only roughly measure the radiation intensity.

1.1.2、 Semiconductor Detectors

The circuit principle and data processing method of semiconductor detectors are almost the same as scintillation detectors, except that the conversion process of semiconductor detectors can be abbreviated as "ray → electrical pulse", while scintillation detectors are "ray → flash → electrical pulse".

This instrument uses PIN tube as sensitive element, it has almost no electric gain, so it needs to be used with extremely sensitive electrostatic amplifier. PIN is less sensitive to higher energy γ radiation, it can be used to measure stronger radiation and achieve larger range; it is more sensitive to α and β radiation, so it is mainly used to measure α and β radiation. However, because the effective area of PIN is small, mainly used to determine the stronger α , β radiation sources, generally not applicable to the assessment of surface contamination.

Both α and β rays are easily shielded, especially α rays, which are almost impossible to penetrate the housing of the instrument, so the housing is opened with windows.

The PIN is sensitive to visible light and the window must be shaded from light, as well as being dust or water resistant. On the inside of the window, there is an aluminized Mylar film with a maximum thickness of 5 μ m. On the outside of the window, an opaque plastic sheet of 150 μ m thickness is covered. The factory setting allows the window to pass through the higher

energy β -rays, but not the common α -rays. If you need to measure α -rays or lower-energy β -rays, you have to remove the plastic sheet. At this point, only the Mylar film inside the window remains in front of the PIN tube, and higher-energy α -rays can pass through, although they will lose energy and quantity.

When the plastic sheet is removed, trace amounts of light will still leak in under bright light, so it should not be used under bright light. For testing the energy spectrum of α -rays, a dark vacuum environment is usually used.

The film on the inside of the window is extremely thin and therefore easily damaged. Do not remove the plastic sheet on the outside of the window unless it is particularly necessary. Removing the plastic sheet will also cause the waterproofing to be damaged and not achieve the designed waterproofing level.



Warning

PIN detector is a bare chip, tearing, puncturing the protective plastic sheet and other operations will damage the airtight, so that water vapor and dust contact the chip, shortening the life of the chip, such failures are not covered by the warranty.

PIN detectors, although they provide a dose rate display, are converted to 662 keV γ -rays, which is highly influenced by the type of radiation measured, its energy and the measurement environment, making **the readings unreliable**.

1.1.3、 Multi-channel analyzer

After the pulse voltage is captured by the ADC, it is first counted by the CPU or a specially designed digital circuit. The 8-bit ADC, for example, has a resolution of 256 steps (28). The purpose of the statistics is to "count" the number of pulses for each level and then display them on a histogram with horizontal coordinates increasing from 0 to 255 and vertical coordinates representing the number of pulses for each level, i.e., to classify the electrical pulses by their amplitude.

Long ago there was a need in physics to count the number of pulses of a specific voltage in order to detect a specific event. People made a counting device that outputs a counting pulse to drive a totalizer when pulses of a specific voltage range are input (various approaches existed in the early days, such as a mechanical device driven by a solenoid, a voltmeter head that converts to an integral voltage and then drives the scale as a quantity, etc.). For other voltages it does not respond. In research, one such counter is referred to as a channel, and the corresponding product is called a "single-channel analyzer" (SCA). When a more comprehensive amplitude classification is needed, either dozens or hundreds of single-channel analyzers are used, or the voltage range of the single-channel analyzer response is regularly adjusted. The former is very clumsy, and the latter takes a long time and is not suitable for situations where multiple voltages need to be observed simultaneously. In 1952, Atomic Instrument Company (USA) introduced a product with twenty channels integrated, using the name Multi-Channel Analyzer (MCA). On this instrument, the voltage range corresponding to each channel is called the channel width, and the channel corresponding to one voltage is called the channel address (CH).

Multichannel analyzers are just names that have been used to this day, and their principles have changed many times over the course of nearly a century of history. Today's multichannel analyzers are almost all based on commodity analog-to-digital converters (ADCs), the difference being mainly in the means used to capture very narrow pulses. Before the ADC for pulse spreading or peak hold, so that the low-speed ADC can be collected, known as "analog multi-channel"; with high-speed ADC (usually sampling rate $\geq 50\text{M}$) directly sampled, and then combined with high-speed digital chip algorithms for processing, known as "digital multi-channel ". The KC761 has three multi-channel analyzers inside.

The channel address of the pulse, i.e., the pulse voltage, represents the energy of the ray. However, this correspondence is affected by the crystal,

the optoelectronic device, and the acquisition circuitry, and there is some nonlinearity, which usually requires function fitting. Different sensors have different fitting curves and need to be calibrated at the time of production to solve for the coefficients of the function. With these coefficients, the channel address can be converted to energy and the transverse coordinates can be rearranged in linear or logarithmic energy to obtain an energy spectrum plot.

For example, if an instrument picks up 10,000 pulses, there are 9,998 in 1,000 channels and 2 in 333 channels, so it is possible to know the energy corresponding to 1,000 channels, for example, there are 9,998 copies of 1 MeV rays and 2 copies of 333 channels corresponding to 382 keV rays. If the energy spectrum is scaled by energy, as described above, the channel sites corresponding to each scale are not strictly uniform.

1.2、 Energy Resolution

Whatever the detector, due to its own physical characteristics, the voltage obtained is jittered, for example, it is difficult to appear 9998 pulses of exactly 3V, but the actual distribution will only be in the range of, for example, 2.5V to 3.5V, close to the normal distribution. After the statistics, the spectral peaks will be wider than the actual energy distribution of the rays. The relative half-peak width is generally used to describe the performance of an energy spectrometer, which is the ratio of the width at half the height of the spectral peak to the absolute position of the spectral peak centerline, also known as the energy resolution. The smaller the resolution value, the better, but the more expensive the sensor.

Since the energy spectrum is a count of pulse heights, obviously the more pulses collected, the better. In order to get a nice energy spectrum quickly, the distance between the instrument and the radioactive source should be adjusted to find a position where the dose rate is large, but not over the range.

The KC761B has a medium level of resolution and can correctly identify more than two dozen common nuclides. Higher resolution sensors are now

becoming popular for cadmium zinc telluride (CZT) materials, and high-purity germanium detectors (for γ -rays) are still the highest resolution. However, these detectors are more expensive, and some require high-voltage power supplies or refrigeration, and cannot be used for the time being in products such as the KC761, which aims at widespread availability of the new technology.

1.3、 Dose rate

Similar to the Geiger counter, this instrument also determines the dose rate of radiation based on the frequency of pulses. Since the energy represented by the pulse is known, the number of pulses can be corrected according to the sensitivity of the sensor to different energy rays to obtain a dose rate that is still accurate, a practice called **energy compensation**. In addition, the body's ability to absorb different energy rays varies, so a dose equivalent rate can also be obtained.

Any instrument needs to meet a number of prerequisites in order to measure accurate dose rates, and energy spectrometers are no exception.

(1) Impact of energy

The electrical pulses caused by the rays must be above a certain voltage to trigger counting. If the threshold is set too low, noise will also be perceived as a pulse and produce false counts. In other words, the rays must have sufficient energy, and for the KC761 the lower limit is about 30 keV and 9keV for KC761B. If it is below, it cannot be measured; if it is a broadband spectrum from a dozen to a few tens of keV, as in the case of medical X-ray machines, or low-energy Compton scattering of high-energy rays, the count will be falsely small because the instrument will simply discard the part below the minimal energy.

In fact, in order to measure the lowest possible energy, the threshold for identifying the pulse height has been set very low, typically just above the vast majority of electrical noise. Based on the random nature of the noise,

there will always be some that enter the threshold and are counted, resulting in large errors in the background count rate and dose rate.

(2) Effects of radiation intensity

The scintillation counter is only suitable for a narrow range of radiation intensities, with a dynamic range wider than that of a normal Geiger counter, but narrower than that of a Geiger counter with the waiting time technique (TTC). Due to the high efficiency of the scintillation counter, radiation of moderate size (e.g. 1 mGy/h) exceeds the range. After the range is exceeded, the pulses are connected so that there appears to be no pulses, so even very large radiation is measured as small. In order to reduce the probability of misleading, as soon as the scintillation detector exceeds the range, the instrument immediately switches to other means to avoid missed alarms. The strong radiation testing capability of the instrument is mainly used to avoid missed alarms, and the confidence level of the dose rate is not high.

The contribution of noise is larger when the radiation is very weak and close to the background. At this time, the energy spectrogram should be observed to determine the presence of radiation outside the background, the dose rate may have a error.

This instrument is mainly used to observe the energy spectrum of γ rays, and although it provides dose rate display, it is for reference only. For α and β rays and neutrons, which are usually used mainly for counting, its dose rate is influenced by many factors and has only qualitative reference significance.

2、 Instrument features and functions

The parts of the instrument are shown in the figure below:

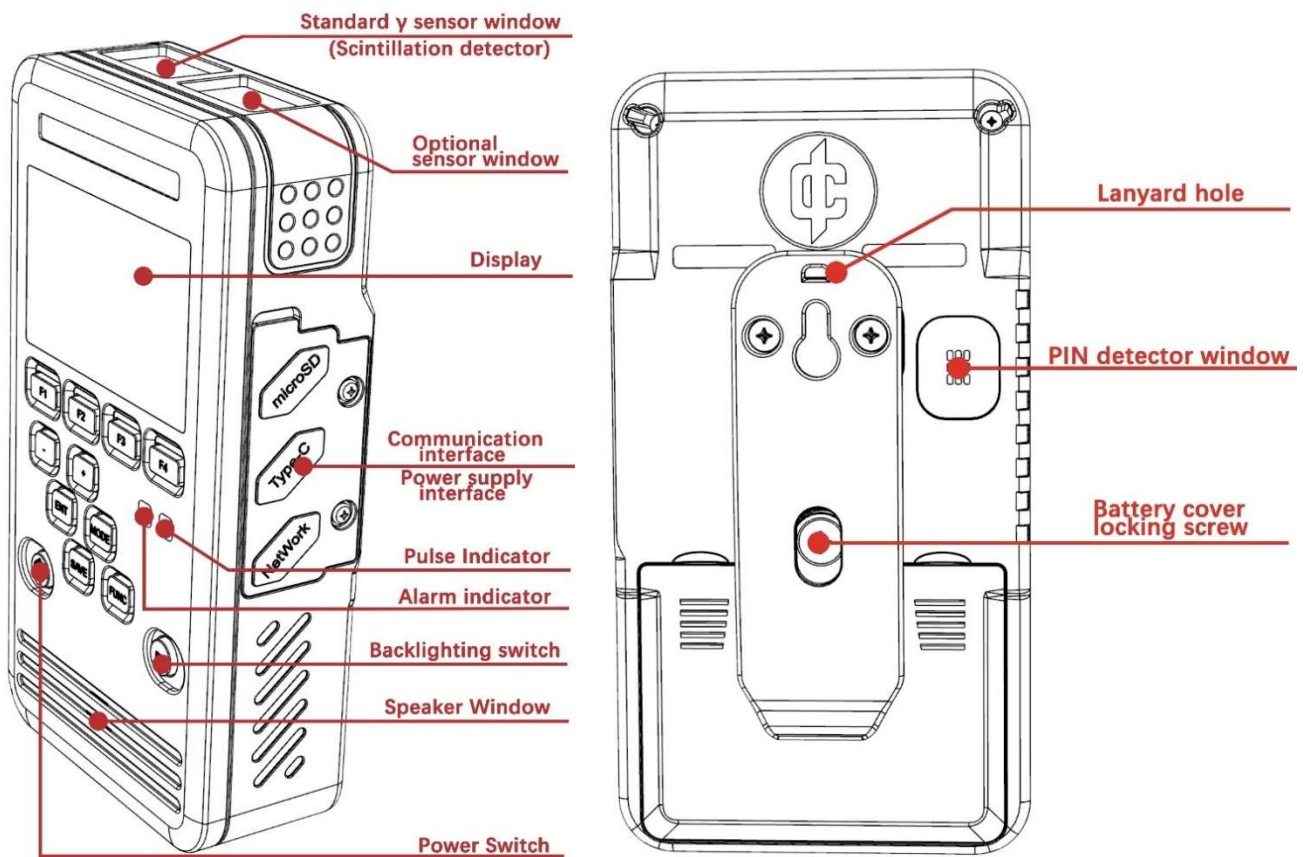

2.1、 Features of the instrument

(1) Feature-rich

Equipped with 2.54cm³ cesium iodide (thallium) scintillation detector and 9mm²PIN detector as standard, it can measure α , β and γ rays.

Each sensor has a separate multi-channel analyzer, all of which can perform spectral analysis and counting.

(2) Power saving and easy access to power

Uses three 5AA batteries, which are replaceable and easily available.

Under the background radiation, the whole electricity is only 6mA, which can work continuously for about ten days. The power-saving state can further extend the time.

(3) Complete, portable

The overall mass is about 300g. Most functions can be achieved without connecting to a computer or mobile app.

(4) Full range of interfaces

With Bluetooth and RJ45 network interface, it can be connected to cell phones and computers, and can be remotely observed through the cloud platform (optional). RJ45 interface supports POE power supply, no need to set up another power line, convenient for deployment construction. TF card can be used to store spectra and count values.

(5) Waterproof design

With IP65 protection level, it can be used normally in the rain for a short period of time.

2.2、Sensors

The sensors configured for this instrument are listed in the table below :

Model	γ -Ray Sensors	α , β -Ray Sensors	Neutron Sensor
KC761	KC7601.21	3×3mm PIN	Optional
KC761B	KC7601.22	3×3mm PIN	Optional

Information of each sensor is as follows:

(1) KC7601.21 (For KC761)

10×10×25.4mm CsI(Tl) crystal, 2×9mm² SiPM, energy resolution about 12%.

(2) KC7601.22 (For KC761B)

10×10×25.4mm CsI(Tl) crystal, 36mm² SiPM, resolution about 7.5%.

(3) KC7601.23 (Experimental, not yet released)

10×10×25mm CsI(Tl) crystal, 36mm² SiPM.

(4) KC7601.31 (Optional, not yet released)

6×6×3mm ⁶Li glass, 36mm² SiPM.

With the exception of the PIN detector, the sensors have built-in memory that can be automatically recognized by the instrument and loaded with the calibration data from it.

 Do not attempt to disassemble the sensor and do not squeeze the sensor housing. Removing or squeezing will immediately invalidate the calibration data.



Sensors may contain highly toxic substances.

2.3、 Instrument performance

(1) Energy scale of γ -rays

At completion of production, in the range of 100 to 10kcps, uncertainty $\leq \pm (5\% + 20\text{keV})$ at $23\pm 5^\circ\text{C}$, or typical uncertainty $\pm (2\% + 10\text{keV})$.

(2) Energy resolution of γ -rays

Subject to the technical parameters published by the sensor. Additional resolution degradation of the instrument (95% confidence level): $\pm (2/E \times 100\%)$, where E is the peak center energy in keV.

(3) Absorbed dose rate of γ -rays (not guaranteed)

Background $\sim 100\mu\text{Gy/h}$, uncertainty $\pm 15\% @ 662\text{keV}$

Compensated energy response: $-15\% \sim +23\%$ ($80\text{keV} \sim 1.5\text{MeV}$), $-23\% \sim +43\%$ ($30\text{keV} \sim 2\text{MeV}$)

Strong radiation warning : $100\mu\text{Gy/h} \sim 100\text{mGy/h}$, $-50\% \sim +100\% @ 662\text{keV}$. Since energy compensation is not possible at this time, the error may be greater at other energies.

(4) Dose equivalent rate of γ -rays (not guaranteed)

$\leq 100\mu\text{Sv/h}$ with typical uncertainty $\pm 15\%$

$> 100\mu\text{Sv/h}$ with typical uncertainty $-50\% \sim +100\%$

Dose equivalent (Typical value at $\leq 100\mu\text{Sv/h}$, only for KC761B):

HP(0.07): $\pm 30\%$, HP(3): $\pm 20\%$

Dose equivalent accumulation limit: $\sim 10\text{Sv}$

(5) α and β ray measurement

Amplitude scale: count rate is provided for relative measurement, absolute accuracy is not guaranteed, and users can calibrate it by themselves.

Counting rate nonlinearity $\leq 10\%$ (in sensitive energy range, at 10cps to 5kcps).

Energy scale of β -rays at $23\pm 5^\circ\text{C}$: ($50\text{keV} \sim 2\text{MeV}$). Typical uncertainty $\pm 20\%$ (room temperature, vacuum, reference value, not guaranteed).

Energy scale of α -rays at $23\pm 5^\circ\text{C}$: (1.5MeV \sim 6MeV). Typical uncertainty $\pm 20\%$ (room temperature, vacuum, reference value, not guaranteed).

i The instrument cannot completely identify α , β , γ rays or neutrons, and the count rate is the total effect caused by all rays. The PIN detector is highly susceptible to electromagnetic field interference and false counts.

(6) Neutron measurement (optional)

Subject to the technical parameters published by the sensor. Additional uncertainty of the instrument (when the count rate is $< 10\text{kcps}$, it is considered by equal pulse period):

Additional uncertainty of energy: $\pm(2/E \times 100\%)$, where E is the peak center channel address.

Additional uncertainty of counting rate: $\pm(5\% + 2\text{cps})$.

(7) Measurement time

Accumulation time of energy spectrum: 1s \sim 86400s (maximum pass rate of 30kcps for scintillation detectors and 10kcps for PIN detectors).

Dose accumulation time: any time, since the last time the user clears the accumulated dose, until the accumulated dose is viewed, non-volatile storage cycle $\leq 1\text{h}$, shutdown and save.

(8) Stability

Temperature stability: within the range of $-20\sim 50^\circ\text{C}$, amplitude drift $\leq \pm 10\%$, energy drift $\leq \pm(5\% + 20)\text{keV}$ (typ.).

Long-term stability: typical value of amplitude drift $\pm 10\%/a$, typical value of energy drift $\pm 5\%/a$ (temporarily not guaranteed).

(9) Power consumption and battery life

The expected endurance time when using alkaline dry batteries under natural background radiation environment is as follows:

	γ -Ray Sensors	Other sensors	
Regular state	7d	7d	
Power saving state	L1/L2	14d	
	10d/20d		

Note: Backlight, vibration, bluetooth, RJ45 interface OFF, Low volume.

(10) Environmental parameters

Temperature range: -10~50°C (normal use); -30~65°C (no guarantee of performance, of which, the LCD display fails below -10°C).

Humidity range: 0% to 100% (short-term, when there is no condensation in the machine).

Altitude: -2000m ~ 15000m (air pressure change rate < 10hPa/min Allowable vacuum).

Waterproof level: IP65 (short-term, must cover the rubber cap on the interface).

Anti-vibration: 1g,20Hz,30min (temporarily not guaranteed).

Fall resistance: any direction, 1.5m (1 time), no functional failure, but there may be performance degradation, display backlight not bright or shell damage.

3、 Instrument installation

The instrument is shipped without batteries. If the instrument is used as a fixed sensor, it can be used without batteries and powered by USB or POE only. If used as a portable test device, batteries should be installed.

3.1、 Battery installation

The battery cover has a waterproof seal and is blocked by a back clip. Although the design contemplates removing the battery cover without removing the back clip, it is more difficult, so it is recommended that the back clip be removed first.

With the back of the instrument up, use a Phillips screwdriver to remove the back clip screw and the battery cover locking screw to remove the back clip.

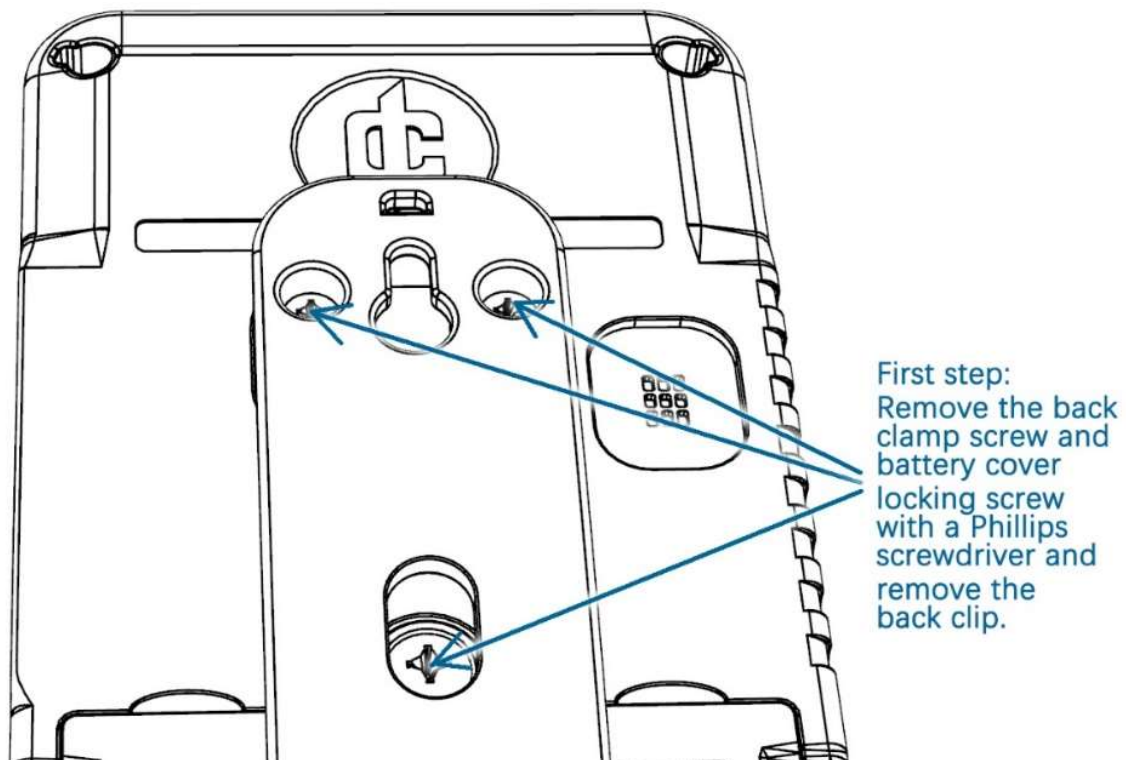

Insert the tab tool into the notch above the battery cover located on either side of the back clip and lift the top of the battery cover with force. Then drag the battery cover and pull it out.

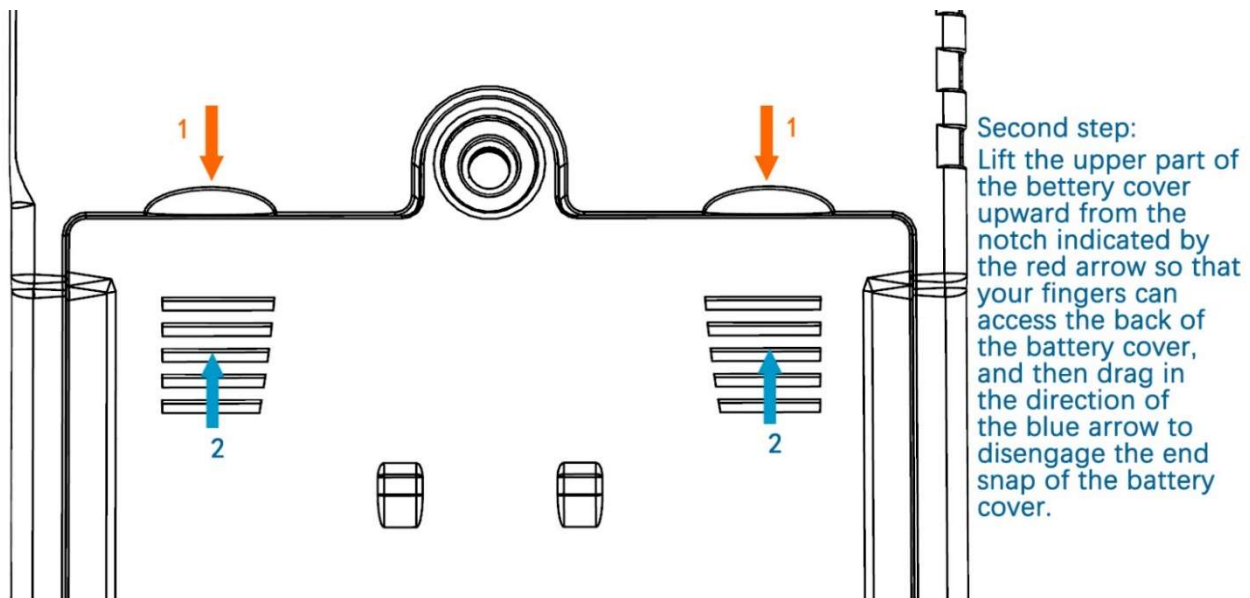

Load three 5AA batteries according to the direction marked in the battery box. Pay attention to the shape of the spring is normal to avoid being pressed under the batteries.

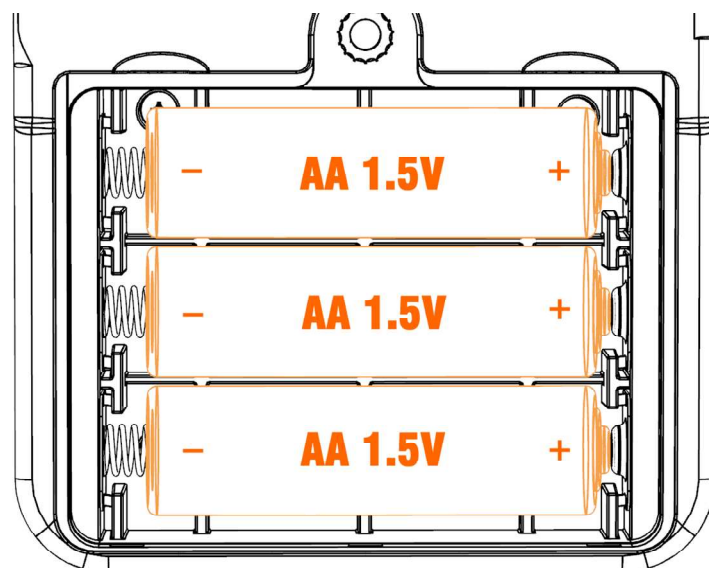

Reinstall the battery cover in the reverse order. Battery cover is more difficult to install, first plug the tail lug into the positioning hole, and then press close to the screw side with force several times, while paying attention to the state of the waterproof seal. If the seal comes off from the slot on the outside of the cover, the seal should be plugged into the slot first.

i If the battery needs to be replaced, it is recommended to use USB or POE alternative power supply to maintain the instrument always with power, so as not to lose time and cause the time scale of stored data to be misaligned.

3.2、 Fixed installation

If you need to fix the instrument in a certain position for long-term monitoring, etc., you can remove the back clip and fix it using the screw holes of the back clip. The screw diameter is $\phi 3\text{mm}$, and the maximum length of screwing into the instrument is not more than 4mm.

For temporary fixing, use the hook holes on the back clip.

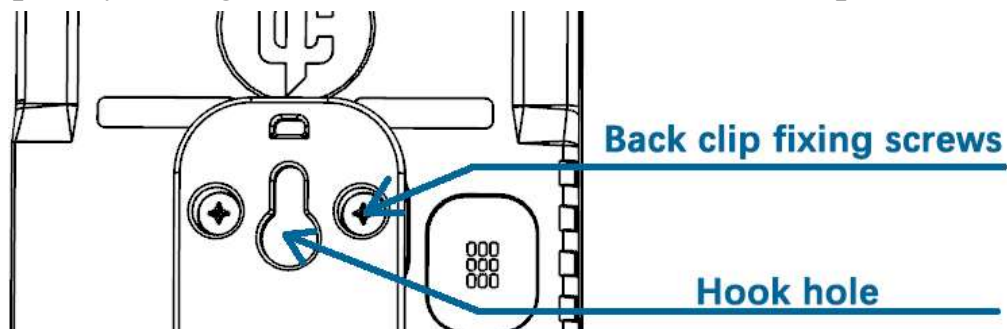

The instrument has a certain ability to protect against rain under the premise that the protective film is available and the waterproof rubber plug is tightly plugged. If the waterproof rubber plug is opened (for example, to connect the network cable), the protection ability will be significantly reduced, and the interface should be made downward and appropriate waterproof and moisture-proof measures should be taken. For long-term fixed use in the outdoors, it must be shielded from rain and sunlight.

3.3、 Install TF card

The TF card slot is under the waterproof rubber plug on the right side of the instrument. Re-cover the rubber plug after installation.

TF cards have a maximum capacity of 32GB and need to be formatted to FAT32 file system before installation. Some cards are not compatible. Please be sure to try to store data to the TF card with the instrument first and confirm that the data is normal before using it officially.

3.4、 Enable Network(Bluetooth)

The connection function of the instrument is off by default, and should be turned on in the software if you need to use it.

Power on → FUNC → Network setting → RJ45 or Bluetooth → On.

It works in the default way after the first opening, and you can modify the setting by yourself.

i When network port is enabled, the power consumption of the device will increase dramatically and the dry battery life will be shortened to less than 1 day. When network is enabled, it is recommended to use USB or POE power supply. When networking is not required, the network connection function should be turned off in time.

3.5、Pulse output interface

There is a 3.5mm hole at the right communication interface to insert a 3.5mm four-segment audio plug for outputting cue pulses and raw sensor pulses(After S-K filter). Pulse amplitude is not adjustable.

The interface is defined as follows (for products after March 2023 only):

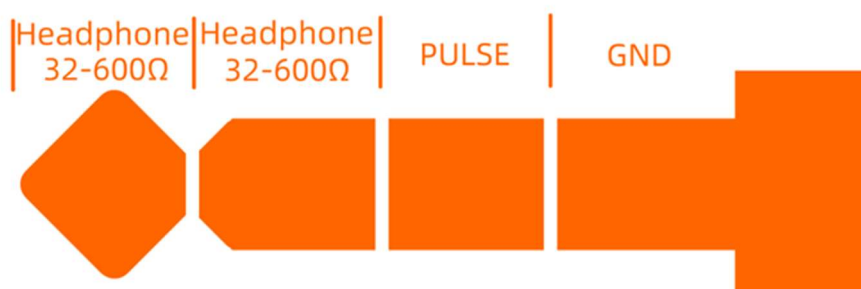

If need to output audio or pulse, it needs to be turned on in the software FUNC setting. In heavy power saving state, the pulse output function is not effective.

- i** Four-segment pins must be used, and the PULSE output must not be short-circuited over time.
- i** The raw pulse width is about 10μs and cannot be directly sampled by any sound card.
- !** The headphones should be slowly placed close to the ear to feel the sound level.
- !** The interface is more fragile and should be avoided under stress.

4、 Operation Guide

This guide focuses on the human-machine interaction and operation logic of the instrument, and it is recommended that users read it completely. This manual defaults to the user being able to understand the operating principles and master the operating essentials on their own through trial and error, and does not require a detailed description of all operating steps.

Earlier versions of the software, the operating logic may be very different from this manual, please refer to the actual operating experience of the device.

4.1、 Interaction interface

Commonly used display interface partitions are shown in the following figure:

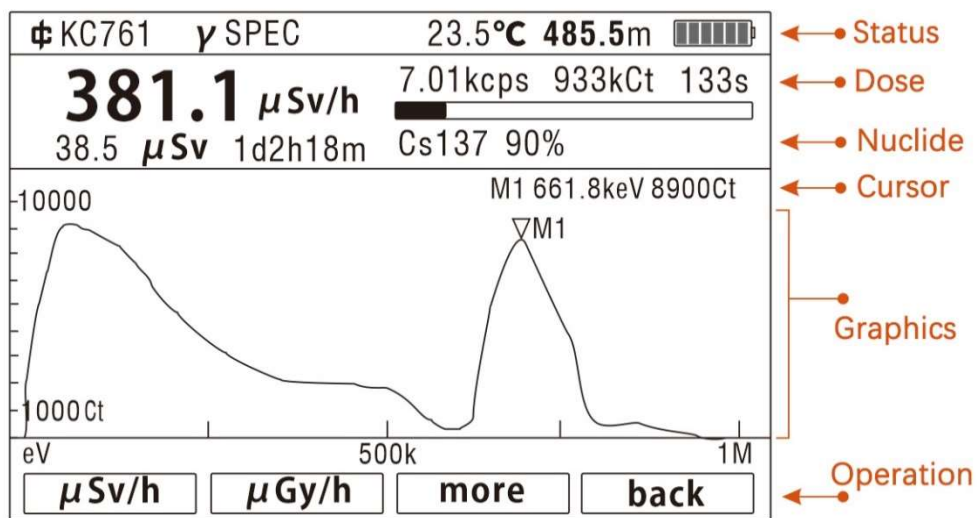

The display style may change as the program is updated.

To save power, the instrument uses a 240×160px monochrome dot matrix LCD screen and the backlight can be turned off at any time. When the backlight is turned on, it will increase the power consumption by about 3mA, and the battery life will be significantly shortened.

The layout and functions of the keyboard are shown in the following figure:

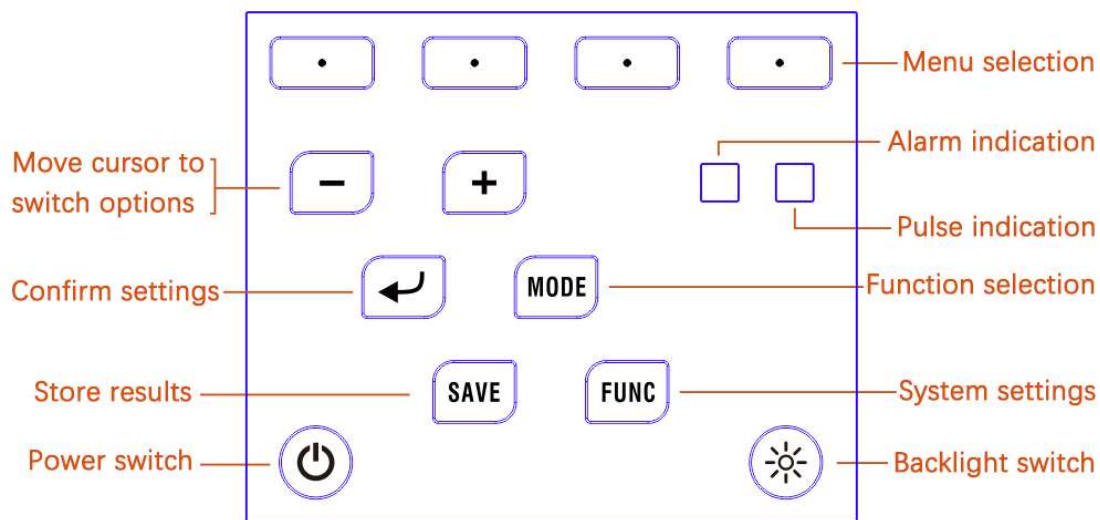

(1) Power Switch

Press and hold the power switch for 0.2 seconds to power on in the off state, and press and hold it for 1 second to power off in the on state.

In the power-on state, short press the power switch to enter the power-saving state, as detailed in 4.2.1.

In the power saving state, short press the power switch, or press any other button to return to the regular mode.

In the power saving state, if you want to turn off the power, you need to return to the regular mode first.

Press and hold for 5 to 10 seconds to completely disconnect the power.

Whether or not the beep sounds when the power is turned on is determined by the setting of BEEP setting item under FUNC.

(2) Backlighting switch

Short press to turn on the backlighting of the display and keyboard, and short press again to turn off the lighting.

After the lighting is on, The time of backlight illumination is set in FUNC.

Press and hold the illuminated switch for 1 second, the backlight is continuously lit, short press to turn off.

(3) System Settings (FUNC)

Press the key to enter the system configuration menu, press the "-" and "+" keys to switch the setting items (with cursor prompts).

(4) Store results (SAVE)

Short press to store the current spectrogram, spectral table, dose rate table and accumulated dose into TF card.

Long press to turn on the automatic storage function, and store the spectrogram and number table into TF card by fixed time interval. The icon will be shown on the display when auto-storage is on. The time interval can be set in FUNC menu. Press and hold again to release auto-store.

If no TF card is inserted, the storage function is not available, but the accumulated dose can be recorded.

(5) Function Selection (MODE)

Short press to enter the function selection menu, use the menu selection key to select the function you need to use.

Press and hold for 1s to enter the sensor selection menu.

(6) Confirm settings (ENTER)

A short press is used to activate cursors, confirm modifications, confirm selections, etc.

When no setting item is activated, short press to open the common setting menu.

(7) -, +

Used by default to move graph coordinates when no setting item is activated.

Used to move cursors in setting menus such as FUNC.

Used to change values or options when a setup item is activated.

Most changes to setting items need to be confirmed by pressing the Confirm setting key. A few of them take effect in real time.

(8) Menu selection

Used to operate the options on the soft menu.

(9) Pulse indication

When using a PIN or neutron sensor, the pulse indicator flashes immediately when the sensor receives radiation particles.

For scintillation detectors, the pulse indicator flashes once every 8 to 64

pulses, in line with the buzzer, due to the high count rate.

This indicator also use to increase the battery charge(only for KC761B)

(10) Alarm indication

The alarm indicator flashes when the set alarm conditions are reached.

When different levels of alarms are triggered, the color and frequency of the alarm indicator flashes differently for differentiation.

Generally, low-level alarms use single-color flashing, and high-level alarms use multi-color flashing, such as red, white and blue alternately.

4.2、 Function Description

4.2.1、 Operation Status

(1) General Status

The default operating state. The type and number of sensors that are turned on in this state depends on the function settings.

(2) Power saving state

Press the power switch briefly to enter the power-saving state in the power-on state. If there is no operation and alarm, the instrument will automatically enter the power saving state after the set time.

The power saving status is divided into two levels, in the FUNC menu of the power saving settings (POWER SAVE) item, you can set the specific entry into what kind of level, the factory default is light power saving.

Heavy power saving is only supported when using a γ -Ray sensor and mounted in the left sensor compartment. If set to use the Right Sensor or Neutron Sensor (optional), or to use the PIN Sensor, only Light Power Save is entered regardless of the power save level set.

 The Auto Power Save (APS) and Auto Power Off (APO) functions take effect only when the battery is used. If USB power or POE power is connected, the APS and APO functions hang automatically and take effect again after the external power supply is removed.

In the power saving state, it returns to the regular state if external power

is connected.

i The network will be automatically turned off when entering the power saving state.

All power saving states will turn off the display, and the instrument will make the alarm indicator blink green at fixed intervals to indicate that it is in the on state.

a. Light power saving: Turn off interaction. By turning off the human-machine interaction functions such as display, pulse indication, and sound, the energy consumption is reduced to about 70% of the regular state.

In light power saving, the energy spectrum or count operates normally, and only the interaction function is turned off. If radiation exceeding the alarm threshold is encountered, the power saving state will be aborted and returned to the regular state with an alarm.

b. Heavy power saving: On the basis of light, the energy spectrum function works intermittently, but the serious alarm function works continuously. The energy spectrum function measures 1 second every 8 seconds, and returns to the regular state and alerts when irradiated by γ -rays or β -rays that exceed the alert threshold. The heavy energy saving function extends the endurance by about 5 times (relative to the regular state), and can immediately issue a serious alarm.

Under heavy power saving condition, the instrument will still record the accumulated dose with an error of up to several times the true value, for reference only.

If the automatic power saving state (APS) is set, the instrument will automatically switch to the power saving state after a specified time and re-timer if strong radiation is encountered or any operation is performed. After the power saving state is awakened by strong radiation, if the radiation is reduced to below the alarm threshold, the instrument enters the power saving state again after a set time. For the total dose rate alarm, it will be in the regular state for a long time after waking up, until the accumulated dose

is cleared or the alarm threshold is adjusted upward, so that the alarm can be eliminated before entering the power-saving state again.

To avoid misunderstanding, Auto Power Off (APO) and Auto Power Save cannot work at the same time, only one of them can be turned on.

In the power saving state, if the battery is low, the buzzer beeps once a minute for a long time. When the battery is exhausted, the instrument automatically shuts down. From low battery to battery depletion, it usually takes more than 1 day.

4.2.2、 Basic Mode

All modes are based on the algorithm of the mode and the selected sensor for dose accumulation. After switching modes, the dose continues to accumulate.

(1) Energy spectrum priority

The energy spectrum graph and data related to the energy spectrum are mainly displayed. The count value and dose rate are displayed as secondary contents. Only one sensor can be used in this mode. When the range is exceeded, an alarm is issued, and it automatically switches to strong radiation mode. The spectrogram does not work normally during strong radiation.

The nuclide identification tool can only be used in the energy spectrum priority mode.

(2) Dose Priority

Displays a trend graph of the count rate or dose rate over time. The count rate and dose rate are displayed in a similar way to the energy spectrum priority mode, but the graph area is slightly smaller and the value area is larger. Only one sensor can be used in this mode. If a scintillation detector is used and its range is exceeded, it automatically switches to strong radiation mode and the dose rate curve is updated as usual.

4.2.3、 Sensor Selection

In Energy Spectrum Priority and Dose Priority modes, press and hold the MODE key to enter the sensor selection menu. The currently used sensor is indicated in the status bar at the top of the display.

Among them

γ : scintillation detector (standard), if two scintillation detectors are installed, followed by the number 1 and 2 to distinguish, 1 is the left sensor. **2 is right sensor and it has not strong radiation alarm function.**

β : semiconductor detector.

n: neutron detector (optional), if two neutron detectors are installed, followed by the number 1, 2 to distinguish.

If a registered sensor malfunctions/communication fails after power-up, the instrument, if it is aware of it, will indicate the malfunction and the value will no longer be refreshed or a short horizontal line will be displayed.

4.2.4、 Alarm

The instrument has three alarm scenarios: dose rate alarm, count rate alarm, and total dose alarm.

Each alarm is further divided into two levels: general alarm and serious alarm.

The dose (equivalent) rate alarm is on by default, the setting range of general alarm threshold is $1\mu\text{Sv/h}$ to $99\mu\text{Sv/h}$ (factory default is $10\mu\text{Sv/h}$), and the setting range of severe alarm threshold is 0.1mSv/h to 9.9mSv/h (default is 1mSv/h).

Counting rate of the alarm default off, set only for PIN detectors and 6Li glass detectors, the general alarm setting range is 1 to 99Cps (default 1Cps), the serious alarm setting range is 0.1 to 9.9kCps (default 0.1kCps). To avoid random rise and fall caused by false alarms, the number of Cps detected by the alarm needs to be higher than the threshold value for at least 6 seconds

within 8 consecutive seconds.

The setting ranges for the total dose alarm are 0.1 to 9.9mSv (default 3mSv) and 10 to 999mSv (default 22mSv) respectively.

When an alarm occurs, the status bar of the display no longer shows unimportant parameters such as temperature and altitude, and the corresponding area shows the type and level of the alarm. The display is fixed for general alarms and flashes for serious alarms. When a serious alarm is triggered, the general alarm is no longer displayed. If there is other information to be displayed, it will be alternated.

In addition to the display, when the alarm occurs, the instrument uses sound, light and vibration to send out prompts.

General alarm: a slow beeping sound, a single-color flashing alarm light, and a short periodic vibration prompt.

Severe alarm: a sharp beep or alarm sound, alarm indicator multi-color alternating high light flashing, repeatedly issued twice a set of vibration prompts.

After the alarm is issued, if the instrument is low on power, the system automatically turns off the vibration, reduces the brightness of the alarm light, and the sound signal remains unchanged.

After the alarm event is eliminated, the alarm is delayed for 3 seconds to stop. When the alarm occurs, short press the light button to pause the sound and vibration for 3 minutes, and repeat the button will re-timer. If the alarm is not removed, the sound and vibration will be emitted again when the time is up.

The dose rate and count rate alarms cannot be turned off. The total dose alarm function can be turned off.

The switch and threshold of the alarm function are set in the alarm submenu under the FUNC menu.

4.2.5、Nuclide identification

Radioactive isotopes emit rays with specific energies. By measuring the energy of the rays, the spectrometer can identify the isotope that produces the rays.

Some isotopes emit rays of various energies, and the amplitude of each has a specific proportionality, which is like a key with multiple teeth, which can only open specific locks, and the identification is more reliable. Some isotopes emit only one type of energy ray, and if there are other rays in the vicinity, they are not easy to recognize them.

(1) Auxiliary manual identification

By default, the instrument is equipped with the auxiliary manual identification function. Manually move the cursor to the top of the characteristic peaks on the energy spectrum, if the energy value corresponding to the cursor is similar to the energy of the radiation emitted by a certain isotope, the instrument will display a vertical dotted line in the position corresponding to all the radiation energies of the isotope, and at the same time display the symbols of the isotope. The height of the dotted line indicates the proportionality of the amplitude of the rays of different energies. Since low energy rays are more easily absorbed by the sensor, and high energy rays tend to penetrate the sensor without having full effect, the peaks of the spectra are not equal even if the dashed lines are of the same height, and usually the higher the energy, the shorter the peaks. However, for dashed lines of equal height, if one corresponds to a distinct spectral peak, then there should be at least a slight bump near the other. If there is none at all, it is a sign that it is not that isotope. In short, the more the spectral peaks overlap with the cue line, the more likely it is to be that nuclide.

The figure below shows a typical energy spectrum diagram, where two very high cue lines appear when the cursor moves to the first characteristic peak, while the symbol ^{176}Lu is displayed. since the second characteristic peak also coincides exactly with the cue lines, it can be assumed that the radiation originates from ^{176}Lu . As you can see from this graph, even though

the cue lines are equal, the high energy peaks are lower. The sharp peak on the far left is produced by the fact that this is close to the instrumental noise floor, and the instrument concentrates all the energy near the noise floor on the far left side of the display, and has no specific significance. The second peak from the left is the result of the superposition of the Compton scattering of the uranium background radiation and the ^{176}Lu radiation, and is also of no particular significance.

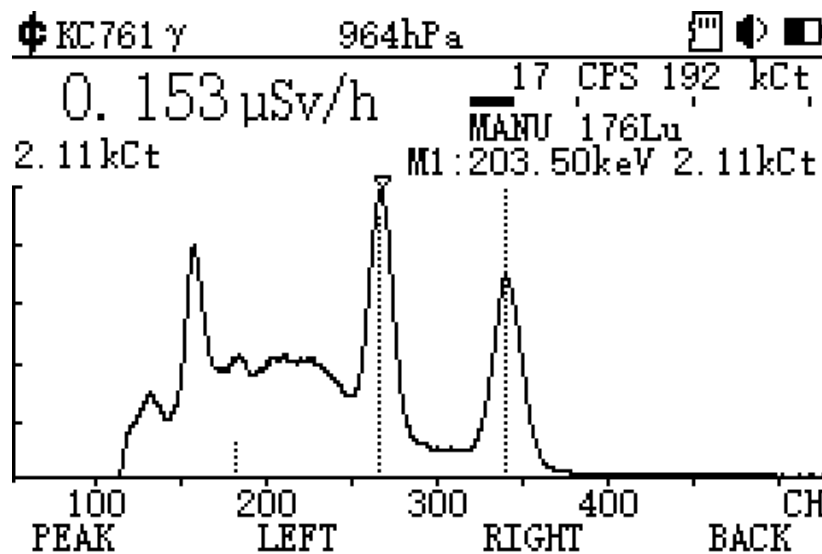

(2) Automatic Identification

The automatic identification function needs to be enabled in the menu. Enter the spectrum priority mode, select "Configuration" on the main menu, select "Nuclide Identification", and then select "Auto Identification".

Once turned on, the instrument will recognize all the peaks it can find, and by comparing with the nuclide library, the nuclide with the highest correlation will be recognized as the result. The automatic identification will also display a prompt line, which is convenient for manual review.

(3) Precautions

Whether it is automatic or manual identification, it is necessary to accumulate enough counts first to smooth the curve. It is generally recommended that the number of counts be 30kCt or more, the more the better.

Many isotopes produce radiation in the low-energy region (<250keV),

resulting in a very crowded low-energy region, even one energy corresponding to multiple nuclides. The low-energy region is in turn characterized by the presence of a large amount of background radiation, which can lead to spectral bulges even in the absence of noteworthy rays. Priority should be given to finding peaks in the middle and high energy regions for identification.

The fatness of the spectral peaks should be predicted based on the resolution of the sensor and the energy of the rays. Obviously too thin peaks are usually false peaks, and obviously too fat bulges are usually a combination of multiple neighboring peaks or Compton scattering, which is not representative of any of the peaks at its highest point and is a meaningless peak. Neither overly thin nor overly fat peaks can be used for nuclide identification.

The instrument is subject to energy drift, and even a 2% drift can cause the peaks to deviate severely from the correct energy. In the low-energy region due to the very high crowding, a slight drift can lead to a sheeted peak. Drift is difficult to avoid completely, and when identifying, if there are peaks in the middle and high energy regions, the peaks in the middle and high energy regions should be used in preference to the peaks in the middle and high energy regions. If the peaks do not coincide with the cue lines, you should observe the overall trend of the spectrogram, move the cursor left and right to understand the neighboring isotopes, and imagine whether the spectrogram can coincide with multiple cue lines after a slight zoom to determine whether it is the cue isotope.

In the left image below, after shifting the cursor, two cue lines are seen that overlap with the peaks, corresponding to the isotope ^{60}Co , although they do not overlap completely, and there is a difference of a few tens of keV, which makes it likely that the rays are from a cobalt source. When the cursor coincides with the rightmost peak, the ^{24}Na cue line appears, but there is no peak on the right contour cue line at all, so the presence of ^{24}Na can be ruled

out. Trace Optimization 2 can be turned on to highlight the peaks in the high-energy region.

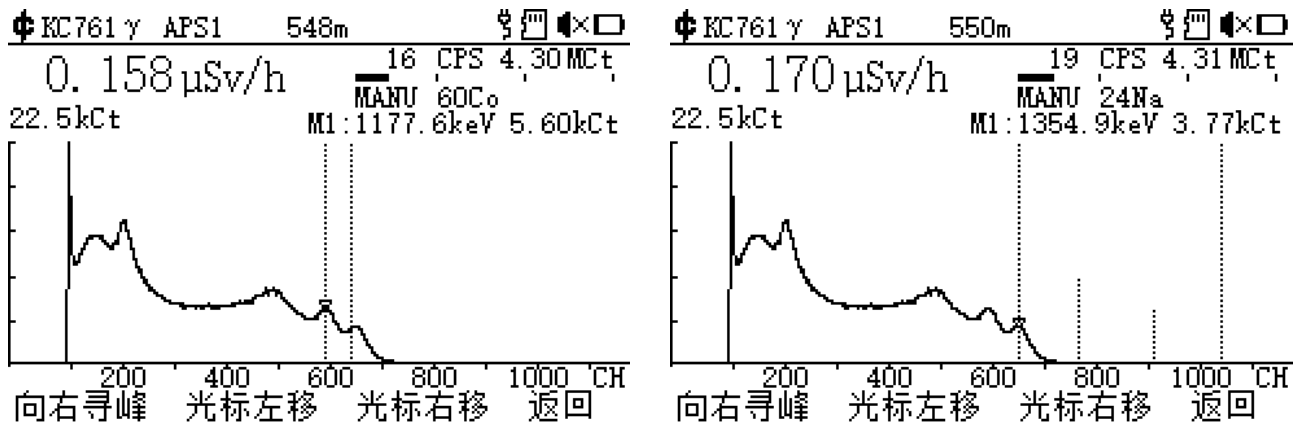

If conditions permit, try to correct the energy before the test, see section 5.1.

4.3、Menu settings

The state at the last power off is maintained by default when the power is turned on.

At power on, the instrument automatically asks for the status of each sensor and registers the sensors with normal communication to the sensor list of the instrument. The instrument interrogates and registers in the following order: left sensing module, right sensing module, and PIN detector.

When the instrument is turned off, the settings and dose accumulation data of the power-on state are saved. In order to avoid shortening the life of the memory by writing it frequently, some operations and data are only stored at regular intervals (e.g. every 30 minutes) and will be forced to be stored once when the instrument is turned off. If the power is forcibly disconnected while the power is on, it will not be saved.

If the factory settings are restored, the instrument defaults to energy spectrum priority mode, using the first registered sensor.

4.3.1、MODE menu

Short press MODE to enter the mode selection menu, and short press

MODE again to return to the mode main menu of the current mode.

The mode selection menu is shown in the table below.

Option	Name	Function	Notes
Energy spectrum /SPEC	Energy spectrum priority mode	Enter energy spectrum priority mode	
Dosage/DOSE	Dose priority mode	Enter dose priority mode	
Back/BACK		Return to the menu before pressing the MODE key	

Press the button to enter the corresponding mode.

Press and hold the MODE key in the energy spectrum and dose mode to enter the sensor selection menu, as shown in the table below.

Option	Name	Function	Notes
Scintillator/CsI	Scintillation detector	Left sensor, specific options subject to actual configuration	
Lithium Glass/6Li	Neutron detector	Right sensor, specific options subject to actual configuration	
Semiconductors/PIN	Semiconductor Detectors	PIN Sensor	
Back/BACK		Return to the menu before pressing the MODE key	

The above table is for reference only. The instrument reads the type of sensor installed in each sensor compartment at power-up and displays them in the order of left and right sensors and PIN sensors, so the names of the options depend on the sensors installed.

It is also possible to select sensors in the configuration/CONFIG menu for users who have difficulty mastering long press operation settings.

(1)、SPEC menu

Each mode has its own top-level menu. The top-level menu of the Energy Spectrum Priority mode is the SPEC menu.

The [First Level Menu] SPEC menu has the following options:

Option	Name	Function	Notes
MARKER	Cursor	Enter the cursor control menu after pressing the key	With subordinate menu

SCALE	Coordinate settings	Set the type of coordinates and their size	With subordinate menu
CLEAR	Reset graphics	Enter the clear graphics confirmation menu after pressing the key	With subordinate menu
CONFIG	Mode Settings	Configure parameters related to this mode	With subordinate menu

The [Secondary Menu] Configuration/CONFIG menu options are as follows:

Option	Name	Function	Notes
IDTF	Nuclide Identification	Enter the nuclide identification setting menu after pressing the button	With subordinate menu
UNIT	Unit Settings	Select the unit for each reading by pressing the key	With setup page
SENS	Select Sensor	Access to sensor selection menu	
BACK	Back	Back to the mode main menu	

The [Secondary Menu] Cursor/MARKER menu options are as follows:

Option	Name	Function	Notes
PEAK	Peak Find	Find the peaks in the display area in order to the right	
LEFT	Move the cursor to the left	Move to the left of the current cursor position	Long press to move continuously
RIGHT	Move cursor to the right	Move to the right of the current cursor position	Long press to move continuously
BACK	Back	Return to mode main menu	

After entering the MARKER menu, the “-” and “+” buttons are still used to move the spectrogram, and the cursor follows when moving the spectrogram. After moving the cursor (including moving the cursor by moving the spectrum) to one end of the display area, continue moving to the other end. Press and hold the PEAK option, or after one continuous peak search, turn off the cursor and press again briefly to redisplay.

The [Secondary Menu] Scale/SCALE menu options are as follows:

Option	Name	Function	Notes
ZoomOut	Zoomed out	Increase the coordinate span and make the graph smaller	

	spectrogram		
ZoomIn	Enlarge Spectrogram	Decrease the coordinate span and make the graph bigger	
Log	Vertical axis mode	Adjust the logarithmic or linear display, and change to LIN after pressing the key.	
BACK	Back	Return to mode main menu	

Scaling is graded, and corresponds to 1, 2, 5, and 10CH per pixel, respectively, and its scale, logarithmic or linear is displayed on the top left of the graph. Scaling is done with the leftmost scale and the right side beyond the highest channel address is displayed blank. The “-” and “+” keys are used to move the horizontal coordinates at any time when there is no other conflict.

The [Secondary Menu] Clear/CLEAR menu options are as follows:

Option	Name	Function	Notes
CLEAR	Clear Spectrogram	After pressing the key, a second confirmation dialog box appears	
PAUSE	Pause Accumulation	Press once to pause the spectrum accumulation, the display changes to START, press again to start accumulation, the display changes to PAUSE.	Indicated by symbols on the display
ADV			With subordinate menu
BACK	Return	Return to mode main menu	

This clear operation only affects the energy spectrum, not the dose rate or accumulated dose. If the single channel site is full, accumulation is suspended and the status bar indicates Channel Overflow.

Subordinate Menu

[Tertiary Menu] Identification/IDFT

Option	Name	Function	Notes
MANU	Cursor Auxiliary Switches	Cursor-assisted recognition after key press	Choose one or the other, visible
AUTO	Automatic identification switch	Automatic recognition after key press	

OFF	Turn off nuclide recognition	Turn off nucleus recognition after key press	
BACK	Return	Return to [secondary] CONFIG menu	

UNIT Settings Page Contents

Option	Name	Function	Notes
RATE	Dose rate unit	Selects the unit of dose (equivalent) rate*	
Energy/keV	Energy spectrum horizontal coordinate	Display the channel address/CH after pressing the key	
BACK		Return to [Secondary] menu	

* The units of accumulated dose (equivalent) are switched simultaneously. A list selection is used, giving all options, moving the cursor up and down with the “-” and “+” buttons, and the Confirm/OK and Exit/ESC buttons appear on the soft menu.

[Tertiary Menu] Advanced/ADV*

Option	Name	Function	Notes
OPTIM	Optimization level	Set the con peak deduction, curve sharpening level	Button switch
DBKG ON	Deduct the background	Press the key to turn on or off the background deduction	Display DBKG prompt
BKG	Set to background	Acquisition of background	Secondary confirmation
BACK	Return	Return to [Secondary] menu	

Optimization levels are divided into three levels, which are cyclically switched after pressing the key.

The optimization levels are displayed in the upper right corner of the graph as L0-L2.

When the background deduction is turned on, the background part is deducted from the spectrum proportionally based on the stored background, but the dose rate and accumulated dose are not affected. This operation does not clear the accumulated energy spectrum data, if you need to clear it, you should operate in the upper menu to clear it.

After pressing the Save Background option, if the total count of the current spectrum is more than 100kC, it will prompt on the secondary confirmation dialog box that the old background data will be overwritten and the Confirm/OK and Cancel/CANCEL options will be displayed; if the total count is

less than 100kC, it will prompt that the total count is less than 100kC and cannot be set as background, please continue to accumulate and try again.

(2)、DOSE Menu

[First level menu] In dose priority mode, the top level menu is the DOSE menu:

Option	Name	Function	Notes
MARKER	Cursor	Enter the cursor control menu after pressing the key	With subordinate menu
SCALE	Coordinate setting	Set the type of coordinates and their size	With subordinate menu
PAUSE	Pause dose drawing	By pressing it, the curve is no longer refreshed, but the recording continues in the background; by pressing it again, the recording including the pause period will continue to be refreshed together.	RUN is displayed after pressing the key
CONFIG	Mode settings	Configure the parameters related to this mode	With subordinate menu

The instrument runs records in the background in all modes, whether it is a dose curve or an accumulated dose, and only displays them in dose priority mode. Switching from another mode to dose priority mode displays the history instead of updating it from scratch.

The dose priority mode still runs the energy spectrum analysis in the background and compensates for energy or equivalent accordingly.

The [Secondary Menu] Configuration/CONFIG menu options are as follows:

Option	Name	Function	Notes
UNIT	Unit Settings	Press the button to select the unit of dose (rate)	With setting page
SENS	Select Sensor	Link sensor selection menu	
BACK	Back	Return to mode main menu	

Dose priority mode and energy spectrum priority mode, the sensor can be set separately and remain valid after reboot.

The [Secondary Menu] Cursor/MARKER menu options are as follows:

Option	Name	Function	Notes
NextPeak	Peak Find	Find the peak in the display area from left to right	
LPEAK	Move cursor left	Search for the next peak to the left of the current cursor position	Long press to move continuously
RPEAK	Move cursor right	Search for the next peak to the right of the current cursor position	Long press to move continuously
BACK	Back	Return to mode main menu	

If there are no other conflicts, the -+ keys on the keyboard are used to move the curve at any time. The curve is moved up to the old and new ends. If no move operation is performed for 30 seconds, the right edge is automatically restored to the latest refresh state. Users who need to stay in a non-up-to-date position for a long time for a closer look should first pause the refresh in the Clear menu.

The [Secondary Menu] SCALE menu options are as follows:

Option	Name	Function	Notes
ZoomOut	Zoom Out Curve	Increase the time span and make the graph smaller	
ZoomIn	Zoom In Curve	Decrease the time span and make the graph bigger	
Log	Vertical axis mode	Adjust logarithmic or linear display, change to LIN after pressing key	
BACK	Return	Return to mode main menu	

When zooming one pixel corresponds to an integer number of time, 1, 2, 5, 10, 15 seconds, up to 1 hour for one screen. The total time per screen is indicated in the upper left corner of the graph, shaped as 30 min. The horizontal axis of the coordinates indicates the relative time, with the units placed in the lower right corner and the cursor indicating the specific moment. The instrument temporarily stores the most recent peak dose every 1, 2, 5, 10, 15 seconds and discards it after 1 hour or when it is turned off. The cumulative dose displayed on the screen is accumulated in real time. To protect the memory life, the accumulated dose is not stored in real time, but every 15 minutes, and the peak and its moment of occurrence for the past 15 min are counted once before each storage (the peak and moment since the last count are counted at the moment of power off). The dose continues to accumulate the next time the machine is turned on. Which can store 2880 peak by 15min (about 1 month) and overwrite the old data if it exceeds. The peaks can be transferred to TF card. The user

zooms in and out with the peak data displayed directly under the corresponding scale, rather than clearing the screen and starting over. New data is poured in from the right side and old data leaves from the left side. The data missing due to intermittent work in the power saving mode or shutdown in the middle of use is uniformly considered as zero.

UNIT Settings Page Catalog

Option	Name	Function	Notes
RATE	Dose rate unit	Select the unit of dose (equivalent) rate*	
LEVEL	Curve vertical coordinate	There are three selectable items: count rate, dose (equivalent) rate, and cumulative dose (equivalent)	
BACK	Return	Return to secondary menu	

*The units of the accumulated dose are switched synchronously; cps or cpm is always displayed. Uses a list page, giving all options, moving the cursor with the “-” and “+” buttons, and the Confirm/OK and Exit/ESC buttons appear on the soft menu. Go back one step after pressing the exit button.

4.3.2、FUNC Menu

The FUNC menu has more content and is displayed in a list. At the bottom of the FUNC menu list, the soft menu shows two options, ENTER and BACK.

The FUNC menu has a cursor that uses the reverse color to indicate the position. Press ENTER to activate the setup item and press “-” and “+” to adjust the options. If the item has a dedicated setup page, jump to the setup page.

The FUNC menu uses a scrolling list, with scrolling driven by the cursor, and the position of the cursor is temporarily stored when you leave the FUNC menu.

The contents of the FUNC menu are listed in the following table.

Menu Item	Name	Function
Language	Language Setting	Toggle between English and Chinese. The

		language of the menu name is mutually exclusive with the actual activation language.
DATE and TIME	Time Setting	Set by year, month, day, hour, minute and second, in two levels of activation. After the first level of activation, the cursor enters the field and needs to be activated again separately for the field that needs to be set.
Illumination		
Brightness	Lighting brightness	Set the brightness of the backlight
Bright duration	Lighting duration	Set the duration of the illumination after it is activated by a short press
Disp		
Contrast	Display Contrast	Set the contrast of the LCD screen
Complementary	Set color mode	Black and white - white and black
POWER SAVE		
APO or APS	Select power saving method	Select whether to use timer shutdown or timer power saving, or turn off the function
APO Time-delay	Timed Power Off waiting time	Set the switch and time of timer shutdown in minutes. The range is 3 to 99min.
APS Time-delay	Timed Power Saving wait time	Set the time to automatically enter the power saving state in minutes. The range is 3 to 99min.
PS Level	Select power saving level	L1、L2、L3
SOUND&LIGHT		
Volume	Adjusting the volume	Loud, low, off
ON/OFF BEEP	Power on/off tone setting	Off, On
KEY BEEP	Button sound setting	Off, On
Count Plus	Particle sound setting	Off, On
Count Blink	Flashing light setting	On, Off
ALARM	Alarm function settings	
Pressure sensor		
Pressure or ALT		Selection of barometric pressure or altitude

		display
Pressure Unit	Set barometric pressure unit	mmHg,hPa,Psi
ALT Unit	Set altitude unit	m,ft
ALTsft	Set altitude correction amount	Set correction value in m, ±999.9m
Radiation Sensor	Select a sensor	Equivalent to the selection made after long press MODE
Radiation Sensor corr		
CORR Dose rate	Dose correction	Sensors 1, 2 and PIN, set fixed offset and scaling, respectively
CORR Energy	Energy correction	Sensors 1, 2 and PIN, set fixed offset and scaling, respectively
Nuclide library		Nuclide library selection and user library import
WINDOW	Set the window length for the average dose rate or Cps	1 to 300s range, works for average dose rate/Cps of all interfaces
Plus out	Pulse output settings	Set which sensor the switch and data originate from
NETWORK	Set connection parameters	Set up network, WIFI, Bluetooth and other connection functions
Auto data saving	Configure storage functions	Set up automatic storage
Device information		
Firmware upgrade		
RESET	Reset instrument	Includes restoring the factory, clearing the accumulated dose, etc.

Three options are included in the RESET/RESET menu: Clear Accumulated Dose, Restore Factory Settings, and Exit. Password for clear accumulated dose is 7601, and a specific 8-digit - and + key sequence needs to be keyed in to access the Restore Factory Setting secondary confirmation page.

The password sequence is: - + + + - + - -. This sequence cannot be

changed.

The update operation may delete data, so the update operation also requires entering the above password.

With the improvement of functions, each menu may have a large adjustment. Due to the limitation of printing lot, it may not be updated in the manual in time, so please refer to the actual product.

4.4、 Other matters to be clarified

(1) The energy spectrometer may receive radiation above the upper energy limit, at which time counts will still be generated and the energy will accumulate to a number of channel sites near the highest. Therefore, the peak on the far right of the spectrum is the sum of all pulses above its energy reading, and the peak position is not real.

(2) Peaks above resolution are clearly unrealistic, e.g. needle-like peaks in the high-energy band should be ignored.

(3) Scintillation detectors can respond to higher energy β -rays, which can also produce tough radiation and behave as a continuous spectrum. When testing, attention should be paid to the interference of β radiation.

(4) The PIN detector has a little sensitivity to γ -rays. β -rays can also cause tough radiation and be received by the PIN detector. When testing for β rays, be aware of interference from γ rays.

4.5、 Usage Tips

This section notes tips for use, and newer versions of the user manual may include more content.

4.5.1、 Optimal incidence direction and distance

This device can be installed three sensors, except for the PIN detector is not interchangeable, and two other sensor compartments can be installed with the various types of sensors. The γ ray scintillation detector should be

used in the left sensor compartment, or it can be moved to the right if the left multichannel analyzer fails (but with limited functionality). Since the main calibration data is stored in the memory inside the sensor, moving and swapping only slightly increases the error.

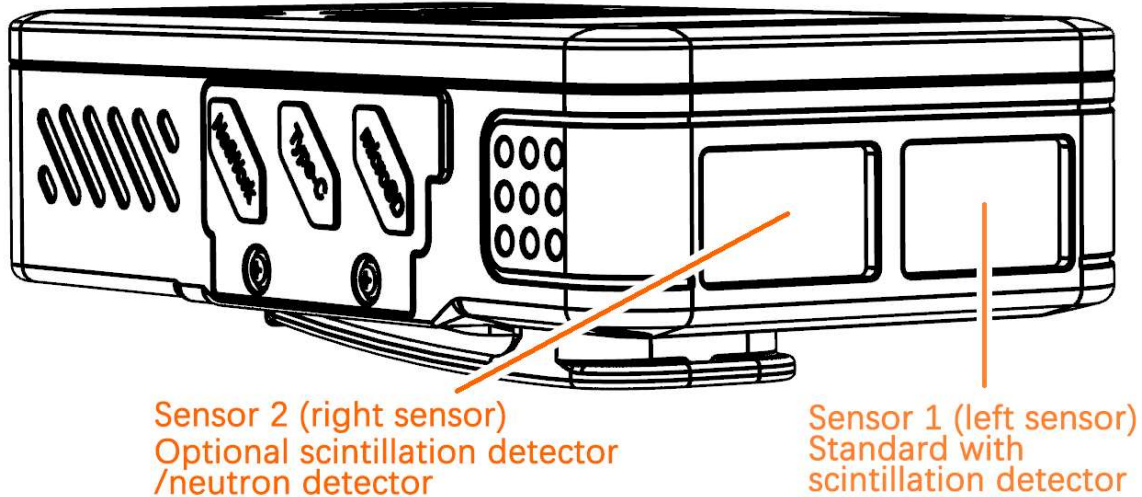

Different sensors have different directions of application. Although scintillation detectors are sensitive to rays in all directions, rays incident in the long axis direction give better energy resolution and peak-to-background ratio. In addition, the thickness of the housing at the window is much thinner than elsewhere, which facilitates the transmission of low-energy X rays. For the neutron detector (optional), the 22 mm length of the moderator is on the side near the window. PIN detector has metal shielding, only in the direction perpendicular to the back of the instrument housing surface with a window, only that direction of the α and β rays can reach the semiconductor surface. The instrument's housing has a very small window open, α and β rays need to be shot through the window of the housing in order to avoid being blocked by the housing.

The best direction of incidence is shown in the figure below. The left figure is suitable for detecting γ rays, and the right figure is suitable for detecting α and β rays.

i Unless it is really necessary, no objects, especially metals or metal-containing minerals, should be blocked between the measured source and the instrument. Metals or minerals should also not be present near the source.

These objects may produce more severe fluorescence, scattering and other effects when irradiated by the source, which can degrade the quality of the ray energy spectrum and easily lead to failure of nuclide identification.

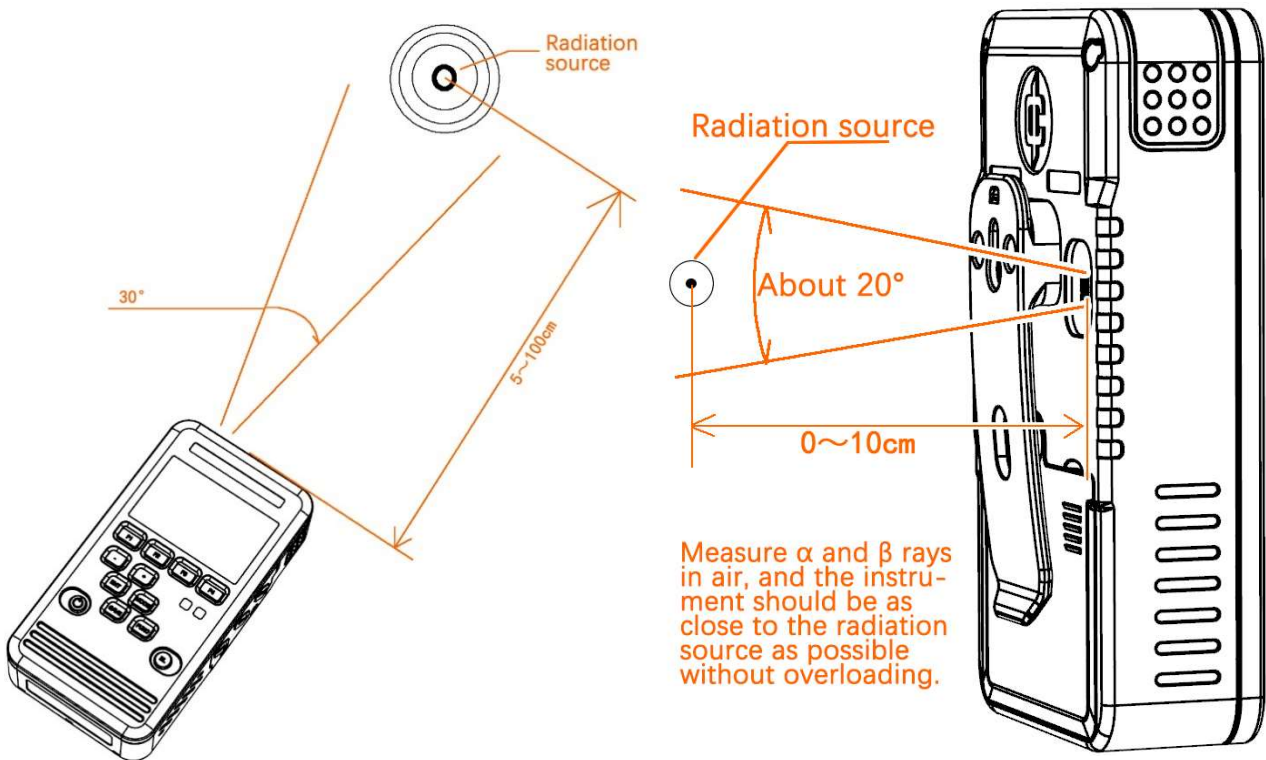

The distance between the radiation source and the instrument should be as close as possible without exceeding 10kcps. In the energy spectrum priority mode, the instrument will use the length of the light column to indicate the radiation intensity, you can adjust the distance between the instrument and the radiation source, so that the light column is located in the recommended range. **The recommended range is only considered from the perspective of rapid measurement, if it is lower than the recommended range, it will not affect the measurement.**

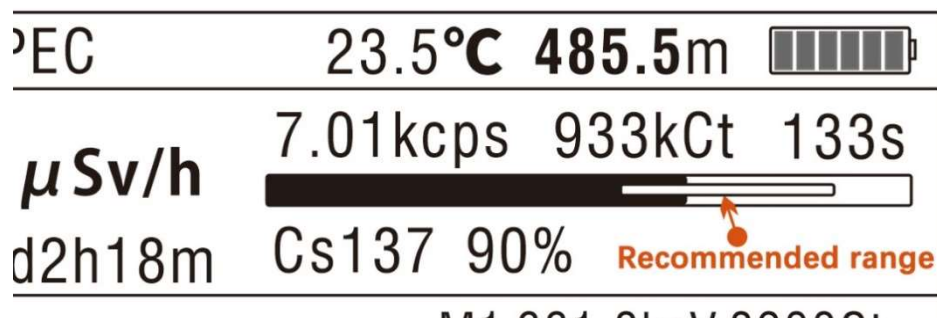

i It should be noted that excessive radiation can cause peak drift beyond

the nominal uncertainty range for KC761(no model letter version). The higher the count rate and the higher the ray energy, the more severe the drift. KC761B model use a ses a very sophisticated circuit technique to eliminate this drift.

i If the radiation source is weak and requires longer measurements, which in some cases (e.g. analysis of natural rocks) may take up to several days, attention should be paid to the stability of the power supply and timely storage of data to avoid any accidents. Stronger sources are not recommended unless they are really necessary.

4.5.2、 Find unknown sources

Sometimes it is not clear where the source is located and a search is required.

Whatever the source, it follows the pattern of large near and small far. The instrument can be moved in all directions to observe changes in the count rate or dose rate readings. For observation purposes, it is recommended to use the dose-first mode. If the reading becomes significantly larger after moving to a certain direction, the source is most likely to come from that direction. If it is not convenient to get close to the source, you can also observe the direction of the significant decrease in reading, its opposite direction is the direction of the source.

For β -rays, the directionality of the sensor can be used for directional measurements. The optimal direction of incidence of the PIN sensor is also the sensitive direction.

For X rays or γ -rays, the instrument is sensitive to radiation from any direction, and the optimal direction of incidence indicates only the ideal direction for measuring the energy spectrum.

For low-energy γ -rays, because the scintillator is not spherical, rays coming from the side will pass through a larger cross-sectional area and the count rate may be slightly higher than the optimal incidence direction. For

high-energy rays, rays coming from the side will penetrate the sensor more and the direction is not obvious. Therefore, do not judge the direction of incoming γ -rays by rotating the angle of the instrument. The installation of a shielding copper block in the sensor bay compensates for the effect of the cross-sectional area, creating directionality to some of the energy.

The more sensitive direction of the neutron detector is similar to the optimal incidence direction of the scintillation detector.

Shielding panels as well as bodies can also be used to shield the rays and provide directionality, but are not always effective for neutron sources. To reduce fluorescence, copper shielding should be used.

The dose rate and the distance from the source are squarely decreasing. Moving the instrument in the direction of the source, the distance to the source can be initially estimated based on the trend of the dose rate becoming larger or decreasing.

4.5.3、 Protecting the quality of energy spectra

Whether the spectrogram is sharp and the height is close to the truth depends first of all on the measured rays themselves, in addition to the performance of the instrument. The source of radiation is usually not a monolithic substance, and the rays may interact with themselves after they have been generated; the rays may also have changed as they are transmitted from the source to the instrument. In order to avoid deterioration of the spectrum, the following techniques should be observed in addition to the direction and distance.

(1) The measured source should be as bare as possible, without unnecessary blocking, especially with heavier metal blocking. The rays will interact with the blockage, causing distortion of the energy spectrum. Iron, stainless steel, lead can cause deterioration of the energy spectrum, even if it must exist, it should be as thin as possible.

(2) There should also be no metals or minerals containing high atomic

number elements near the measured source, even if there is no direct blocking effect, it will bring deterioration due to scattering. For example, testing in a lead box is usually inferior to taking the source out and measuring it on a board. If a lead box is to be used, a larger volume should be used to keep the source away from the lead.

(3) For the lower activity of minerals, powders, etc., rather extend the measurement time, but also to avoid relying on increasing the number to improve the activity. The smaller and thinner the source, the better, as long as the radiation is above background. This is because the source itself blocks the rays it produces, changing the energy spectrum distribution.

5、 Maintenance

This product does not normally require special care, but there are still some issues that need attention in order to keep the instrument in good condition.

5.1、 Stability of the energy scale

As described in Chapter 1, the gamma spectrometer corresponds c-ray photons to data through flash, photoelectric conversion, charge-voltage conversion, pulse shaping, and analog-to-digital conversion. A performance drift in any of these will affect the position (peak position) of the spectral lines, i.e., the accuracy of the energy scale.

For the instability incurred by the device, the instrument has taken compensation and stabilization measures and its effect has become smaller. However, variations in optical coupling between scintillators, spectrum-stabilizing LEDs and silicon photomultiplier arrays are difficult to predict and compensate for. Sensors are semi-airtight components, and when the external atmospheric pressure or temperature changes rapidly, there will be a small change in the internal stress. After a long time there will be accumulated effects.

Therefore, the instrument should not be stored or operated in a place where the temperature or air pressure fluctuates frequently and rapidly. Nor should the sensor be crushed or subjected to strong vibrations.

The energy scale should be calibrated at least once a year after the instrument has been commissioned, or shorter when conditions permit, and every three months for the first six months. If it is subjected to violent impacts, drops, etc., it should be calibrated before continuing to be used. The calibration can be performed with back ground ^{40}K ^{137}Cs or other more clearly characterized sources. If the deviation exceeds the specified technical performance, it can be corrected using the Radiation Sensor Revision-Energy Revision function in the FUNC menu and returned to the

manufacturer for calibration if necessary.

The revised method is such that if there is only one known source, e.g. ^{137}Cs , then only the energy scaling would be set. Measure the known source with the instrument and read the peak energy use maker peak find function. Divide the known energy of that source by the energy read to get the scaling factor. Enter this factor into the instrument as a percentage. Each sensor needs to be tested and entered separately. To minimize errors, the energy of the known source should be located as close as possible to the 500 keV to 1.5 MeV range.

If there are two known sources, the intercepts, or translations, of the lines they form can be found. For example, if one source has a known energy of 59 keV (named m) and a measured energy of 68 keV (named n), and the other source has a known energy of 662 keV (j) and a measured energy of 608 keV (k), the scaling factor (E_z) and the translation value (E_o) are calculated according to the following formula:

$$E_z = \frac{j-m}{k-n} = \frac{662-59}{608-68} \approx 1.117$$

$$E_o = m - nE_z = 59 - 68 \times 1.117 = -16.956$$

In the case of two known sources, one of them should try to be in the low-energy range of 50 to 300 keV, while the other should try to be in the high-energy range of 500 keV to 1.5 MeV, and the energy gap between them should not be too small. When this condition is met, revisions can also be made using nuclides with at least two peaks that are far apart, e.g., using thorium oxide (^{232}Th). ^{137}Cs can be used with KC761B, a low-energy peak of ^{137}Cs (sources requiring a plastic shell).

Also can be done using the ^{40}K peak in the natural background radiation. The ^{40}K peak is usually seen by accumulating for 12 hours and using Spectral Line Optimization 2 (Trace Setup-Advanced-OPTIM, no background deduction shall be used). Measurement of potassium salts such

as potassium chloride allows the 40K peak to be seen within 1 hour.

Using two peak revisions, the accuracy was close to that of sending it back to the factory for calibration.

5.2、 Use of batteries

The instrument uses three dry cell batteries in series with a rated operating voltage of 4.5V. Considering that the user may also use NiCd/NiMH or LiFe dry cell batteries, the actual design is available in the voltage range of 3.0V to 6.0V (1V to 2V/cell).

The instrument cannot identify what battery the user installed, the low voltage alarm point is set at 3.2V, and the protection shutdown point is set at the lowest available voltage of 3V, which is a slightly greater risk of leakage for ordinary carbon dry batteries. Unless necessary, do not rely on the battery that is about to run out of power to force support.

When the battery voltage is lower than the protection point, the automatic shutdown prompt will be displayed and the buzzer will beep one long time every minute. If there is no operation, it will shut down after 30 minutes, and re-timer if there is operation.

Auto Power Off Tips Menu

Option	Name	Function	Notes
DELAY	Delayed shutdown	Stop prompting for shutdown within 30 minutes after key press	
IMMED	Immediate shutdown	Shutdown after key press	
BACK	Return	Exit low battery prompt menu, equivalent to DELAY	

 **The KC761B has a charging function. In order to avoid danger caused by accidental charging, it is prohibited to use any lithium batteries, including rechargeable lithium batteries that simulate the function of a 5AA dry cell battery.**

 When using dry cell batteries, external power can be turned on only for a short period of time (<30min). Prolonged charging of dry cell batteries may be dangerous. Remove the batteries if the external power supply is to be used permanently.

If the instrument is not used for a long time, the battery should be removed. The instrument still has a weak power consumption in the off state, which will increase the risk of battery leakage.

 When replacing the battery, it is recommended to replace the power supply with USB or POE to maintain continuous timing.

If the instrument is freeze, it can be restarted by hold POWER button for 5s or removing and installing the battery.

If the backlight brightness is erratic, usually the battery contact is poor, use rough paper to wipe the electrode and spring surface of the battery compartment.

 Before storing data (SAVE button) operation, please check the battery power and try to use external power supply. Since writing to a TF card consumes a lot of power, if the battery is close to being exhausted or the contact is poor, the moment you press the store button may cause the voltage to drop, resulting in data loss.

5.3、 Use of External Power Supply

Due to the sensitive circuitry inside the instrument, although strict voltage regulation measures have been applied, it is still necessary to make requirements for the quality of the external power supply.

When using USB power supply, you should use a good performance power adapter, whose ripple should not be greater than 0.5%, and conduct high-frequency interference to be small. Poor quality chargers will interfere with the normal operation of the instrument.

When using POE power supply, attention should be paid to the line lightning protection, it is recommended to use the network cable with

shielding layer, and the shielding layer is properly grounded. POE power quality should also pay attention to avoid the conduction of high-frequency interference.

The KC761B turns on the charging function by default. The instrument starts charging the battery immediately after connecting to the external power supply. Prolonged charging of dry batteries may result in leakage, so use NiMH/NiCd rechargeable batteries if external power is frequently connected.

5.4、 Other Notes

(1) The instrument should be maintained intact and avoid working with faults. When in doubt about the performance, it should be calibrated in time; the shell and its accessories, such as protective film, rubber plugs, seals, etc., can be ordered from the manufacturer if they are defective.

(2) Keep clean, wipe the shell with clean water, do not use alcohol or other organic solvents. Be careful to avoid dirt into the crevices of the keyboard.

(3) If the instrument is drenched with water, it should be dried with an absorbent material first, and then shake out the water in the keyboard and speaker holes in the direction of the front panel. Do not open the rubber protection plug before wiping dry.

(4) The screen cover is reinforced glass, if broken, there will be sharp fragments, need to beware of scratches. Glass cannot be replaced alone, if damaged, the front cover assembly should be replaced.

(5) The instrument is slightly airtight. In the event of a sharp change in air pressure, such as for monitoring radiation in a vacuum chamber, the rubber protection plug can be opened to equalize the air pressure in order to avoid damage to the waterproof membrane of the speaker hole. This is not a concern for general civil air travel, mountaineering, etc.

(6) When removing and installing the battery cover, you need to use a

large force, beware of plastic corners to cut your fingers.

(7) Do not disassemble the instrument. Because of the waterproof seal, the instrument is difficult to disassemble, if you need to add options, we recommend sending it back to the manufacturer for processing.

i (8) The instrument contains a very sensitive amplifier circuit, so please keep away from electromagnetic radiation. When implementing important tests, make sure that the distance from cell phones, walkie-talkies and other sources of radiation is more than 0.5 meters. Avoid carrying it in the same pocket as a cell phone, and do not hang it on the same side of your body with a walkie-talkie.

PIN detector is particularly sensitive, a slight electromagnetic field interference will produce false counting, such as close to phones, intercoms, routers, fluorescent lamps, electric mosquito swatters, electric car chargers and any poor quality switching power supply, poor quality LED lights, etc., may cause false counting. When the count is suspected to be abnormal, attention should be paid to exclude the possibility of surrounding electromagnetic field interference.

When using an AC power adapter, the adapter should allow the output to be grounded and grounded at one end. Some switching power supplies (e.g. USB chargers) have common mode voltage ripple of up to tens of volts at the output. This voltage ripple can cause interference by way of local capacitance to ground, causing the instrument to respond incorrectly when near metal, or the human body.

(9) Store in a cool, dry place.

[End of text]



KC761